



**EkoMed**  
Global Asia  
意可曼医疗用品有限公司



[www.ekomedglobal.com](http://www.ekomedglobal.com)

# what's inside

<b>02</b> Who We Are	<b>45</b> Others Summary
<b>03</b> Social Responsibility	<b>46-47</b> Body Bags
<b>04</b> Infection Control	<b>48-51</b> Shoe Covers
<b>05</b> AAMI Levels	<b>52-55</b> Surgical Caps
<b>06</b> Material Descriptions	<b>56-58</b> Hoods
<b>07</b> Testing	<b>59</b> Certificates
<b>08</b> Our Products	<b>60-61</b> Canada Headquarter Ekomed Global
<b>09-20</b> Gowns	<b>62-65</b> Our Sterilization Facility
<b>21-24</b> Scrub Suits	<b>66</b> ISTANBUL Logistic and Transportation Facilities
<b>25-27</b> Lab Coats and Jackets	<b>67</b> EkoMed Global Inc. Contact Information
<b>28-30</b> Protective Coveralls	
<b>31-44</b> Face Masks	

care  
that never quits...



we care about your health!



**EkoMed**  
Global Asia  
意可曼医疗用品有限公司

# who we are

EkoMed Global is a globally integrated manufacturer of disposable healthcare products and a service provider of medical technologies worldwide. At EkoMed Global, we focus on designing and manufacturing a wide range of disposable products that are utilized in hospitals and surgical procedures. At EkoMed Global, we are aware of the current need for new and innovative products, so we are always adding to our product portfolio. All the production processes are managed and monitored in accordance with ISO 9001, ISO 13795, ISO13485, CE standards.

Our primary goal is to provide reliable, qualitative, and continuous production within a overcapacity sterilized environment for the end-user. Our Headquarters is situated in Burlington, Canada . with the manufacturing plant and Sterilization Facility in Hangzhou, China. Within Canada and China, EkoMed has warehouses and operating offices. It is more than a slogan...

**Care that never quits... We care about your health!**

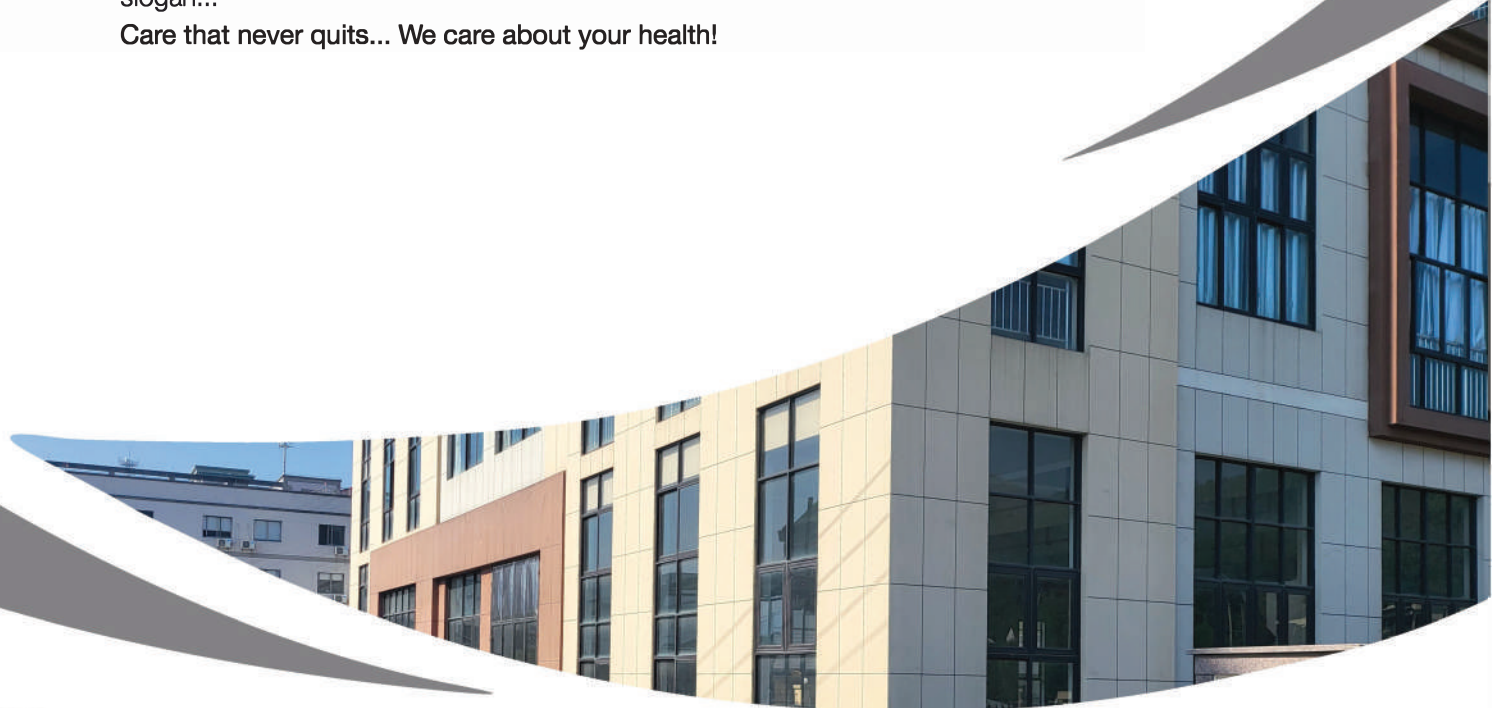



# social responsibility



EkoMed Global always takes the ethical approach towards environmental events, human rights, and economical sensitivity. EkoMed is working to improve the quality and development of our community and the surrounding society we live in. We are educating ourselves to follow and exceed the standards of SA 8000:2014. As a company that serves the health sector, we support social responsibility, especially health-related projects.

Care that never quits... We care about your health!

# infection control

We provide apparel solutions that meet or exceed industry safety standards, including:

- ◆ AAMI Level 1 isolation gowns
- ◆ AAMI Level 2 isolation gowns
- ◆ AAMI Level 3 isolation gowns
- ◆ AAMI Level 4 isolation & protective gowns

We're here to take care of you the way you take care of others. Keep your clinicians and patients safe every step of the way.

Per CDC Guidelines on Standard Precautions, the use of isolation gowns is indicated for some interactions between healthcare workers and patients. Transmission-Based Precautions (Contact, Droplet, and Airborne Precautions) are always used in addition to Standard Precautions. Isolation gowns are indicated for use whenever Contact Precautions are in effect and may be appropriate when Droplet and/or Airborne Precautions are in effect, depending on the nature of the interaction between the healthcare worker and patient as well as the extent of anticipated blood, body fluid, or pathogen exposure. For more information, visit [cdc.gov](http://cdc.gov).

Source: Siegel JD, Rhinehart E, Jackson M, Chiarello L, and the Healthcare Infection Control Practices Advisory Committee, 2007 Guideline for Isolation Precautions: Preventing Transmission of Infectious Agents in Healthcare Settings



# aami levels

Defining the best level of protection for the standard ANSI/AAMI PB70:2012 involves an understanding of the critical zones of a gown and what each level of barrier performance entails so that the best gown is chosen for use by healthcare workers. The critical zones of gowns comprise the front of the gown and the sleeves, which are both primary areas with the greatest risk of exposure to fluids and blood-borne pathogens. As the level increases, so does the need for greater barrier protection for the entire critical zone.

- ◆ Level 1: Minimal level of fluid barrier protection.
- ◆ Level 2: Low level of fluid barrier protection.
- ◆ Level 3: Moderate level of fluid barrier protection.
- ◆ Level 4: The highest level of fluid and viral barrier protection.

<b>Barrier Performance</b>	<b>Barrier Protection</b>	<b>Resistance Measures</b>	<b>Test</b>	<b>Test Criteria</b>
Level 1	Minimal	Liquid Penetration	AATCC42	Water Impact $\leq$ 4,5 g
Level 2	Low	Liquid Penetration	AATCC42 AATCC127	Spray Impact $\leq$ 1,0 g Hydrostatic Pressure $\leq$ 20 cm
Level 3	Moderate	Liquid Penetration	AATCC42 AATCC127	Spray Impact $\leq$ 1,0 g Hydrostatic Pressure $\leq$ 50 cm
Level 4	High	Liquid and Viral Penetration	ASTM F1670 ASTMF1671	Pass

Association for the Advancement of Medical Instrumentation. Liquid Barrier Performance and Classification of Protective Apparel and Drapes Intended for use in Health Care Facilities. ANSI/AAMI PB70:2012. Arlington, VA: AAMI.

# material descriptions

## Spunbond Polypropylene

Standard, cost-effective, and comfortable for basic infection control, this non-woven fabric bonds fibers together to form a single layer that is appropriate only for very minimal fluid exposure.

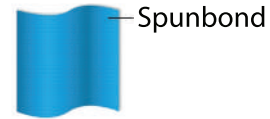

## SMS Material

Strong and breathable, Spunbond/Meltblown/Spunbond (SMS) is a multi-layer fabric composed of inner layers of melt-blown polypropylene between outer layers of spun-bond polypropylene that is ideal for extended wear. Light/medium weight SMS is appropriate for low amounts of fluid and heavyweight SMS may be appropriate for moderate contact with fluids.

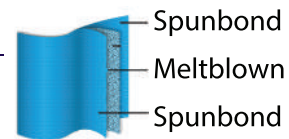

## Coated Polypropylene (Poly-coated)

Soft, spun-bond polypropylene is coated with a layer of polyethylene (plastic) film.

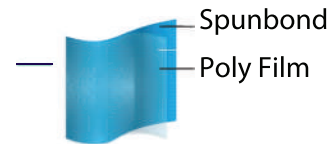

## Polyethylene (Plastic) Film

A single layer of polyethylene (plastic) film provides protection at an affordable cost.

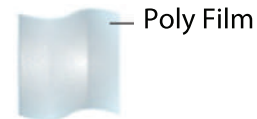



# testing

The Association for the Advancement of Medical Instrumentation (AAMI) standards is designed to help medical-device companies meet global standards for the safe use of medical devices. AAMI introduced the voluntary standard ANSI/AAMI PB70:2012, Liquid Barrier Performance and Classification of Protective Apparel and Drapes Intended for Use in Health Care Facilities, to determine key identification measures for the appropriate selection of protective apparel and drapes, such as medical gowns, for use in healthcare facilities (Pfiedler Enterprises, 2016). The AAMI gown classification stems from four levels of barrier performance, measured accordingly with the following standardized tests;

- ◆ AATCC 42-2017: Measures resistance of fabrics to the penetration of water by impact (AATCC, 2018)
- ◆ AATCC 127-2017: Measures resistance of fabric to the penetration of water under hydrostatic pressure (AATCC, 2017)
- ◆ ASTM F1670-17: Evaluate the resistance of materials used in protective clothing to penetration by synthetic blood under conditions of continuous liquid contact (ASTM, 2017)
- ◆ ASTM F1671-13: Measure penetration by blood-borne pathogens using a surrogate microbe under conditions of continuous liquid contact (ASTM, 2013)



# our products



## gowns

- AAMI Isolation Gowns
- Surgical Gowns
- Chemo Gowns
- Washable Gowns
- Halter Neck



## scrub suits

- V-Neck Scrubs
- Crew Neck Scrubs
- Scrubs Set



## lab coats

## lab jackets

## protective coveralls

- Protective Coverall Type 3-4
- Protective Coverall Type 5-6
- Protective Coverall Type 6



## face masks

- Surgical Face Masks
- 3 Layer Face Masks
- FFP2 & FFP3



## others

- Body Bags
- Shoe Covers
- Bouffant and Surgical Caps
- Hoods

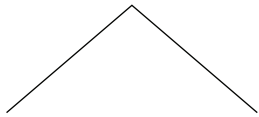
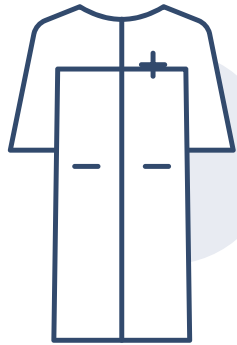

# gowns

AAMI Isolation Gowns

Surgical Gowns

Chemo Gown

Washable Gowns

Halter Neck



# gowns

## Isolation Gown AAMI Level 1

### COLORS



EKM-IG-L1001 (Non-sterile)  
EKM-IG-L1005 (Sterile)



Used for minimal risk situations. Provides a slight barrier to small amounts of fluid penetration.

- 100% SS/SMS/PP
- 30/40 GSM - 0.88/1.18 OYS
- White or Blue
- High-Pressure Liquid Proof
- Laboratory Tested
- High Strength
- All Sizes Available

### DIMENSIONS IN (inch)

	S	M	L	XL	2XL
A	57,1	59,1	61,0	63,0	63,0
B	39,4	41,3	43,3	45,3	47,2
C	7,5	7,9	8,3	8,7	9,3
D	21,7	22,0	22,4	22,8	23,2
E	10,6	10,6	11,0	11,0	11,8
F	6,3	6,3	6,7	6,7	7,5

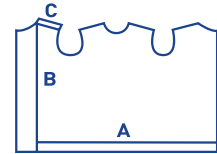

### DIMENSIONS IN (cm)

	S	M	L	XL	2XL
A	145,0	150,0	155,0	160,0	163,0
B	100,0	105,0	110,0	115,0	120,0
C	19,0	20,0	21,0	22,0	23,5
D	55,0	56,0	57,0	58,0	59,0
E	27,0	27,0	28,0	28,0	30,0
F	16,0	16,0	17,0	17,0	19,0

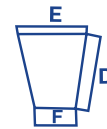



# Isolation Gown AAMI Level 2

gowns

COLORS



EKM-IG-L2001 (Non-sterile)  
EKM-IG-L2005 (Sterile)

Used in low-risk situations. Provides a barrier to larger amounts of fluid penetration through splatter and some fluid exposure through soaking.

- 100% SMS/PP/SMMS
- 30/40 GSM - 0.88/1.18 OYS
- White or Blue
- High-Pressure Liquid Proof
- Laboratory Tested
- High Strength
- All Sizes Available

DIMENSIONS IN (inch)

	S	M	L	XL	2XL
A	57,1	59,1	61,0	63,0	63,0
B	39,4	41,3	43,3	45,3	47,2
C	7,5	7,9	8,3	8,7	9,3
D	21,7	22,0	22,4	22,8	23,2
E	10,6	10,6	11,0	11,0	11,8
F	6,3	6,3	6,7	6,7	7,5

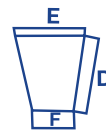
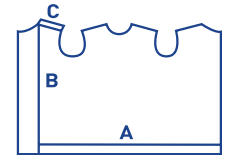

DIMENSIONS IN (cm)

	S	M	L	XL	2XL
A	145,0	150,0	155,0	160,0	163,0
B	100,0	105,0	110,0	115,0	120,0
C	19,0	20,0	21,0	22,0	23,5
D	55,0	56,0	57,0	58,0	59,0
E	27,0	27,0	28,0	28,0	30,0
F	16,0	16,0	17,0	17,0	19,0



# gowns

## Isolation Gown AAMI Level 3

### COLORS

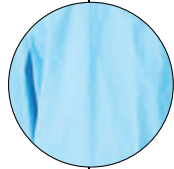

EKM-IG-L3001 (Non-sterile)  
EKM-IG-L3005 (Sterile)

Used in moderate-risk situations. Provides a barrier to larger amounts of fluid penetration through splatter and more fluid exposure through soaking than Level 2.

- 100% PP+PE/SMMS+PE/SS/MMS+PE
- 40/65 GSM - 1.18/1.92 OYS
- White or Blue
- High-Pressure Liquid Proof
- Laboratory Tested
- High Strength
- All Sizes Available

### DIMENSIONS IN (inch)

	S	M	L	XL	2XL
A	57,1	59,1	61,0	63,0	63,0
B	39,4	41,3	43,3	45,3	47,2
C	7,5	7,9	8,3	8,7	9,3
D	21,7	22,0	22,4	22,8	23,2
E	10,6	10,6	11,0	11,0	11,8
F	6,3	6,3	6,7	6,7	7,5

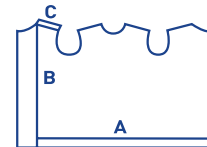

### DIMENSIONS IN (cm)

	S	M	L	XL	2XL
A	145,0	150,0	155,0	160,0	163,0
B	100,0	105,0	110,0	115,0	120,0
C	19,0	20,0	21,0	22,0	23,5
D	55,0	56,0	57,0	58,0	59,0
E	27,0	27,0	28,0	28,0	30,0
F	16,0	16,0	17,0	17,0	19,0



## Isolation Gown AAMI Level 4

### COLORS



EKM-IG-L4001 (Non-sterile)  
EKM-IG-L4005 (Sterile)

Used in high-risk situations. Prevents all fluid penetration for up to 1 hour. May prevent virus penetration for up to 1 hour.

- 100% PP+PE/SMMS+PE/SS/MMS+PE
- 40/65 GSM - 1.18/1.92 OYS
- White or Blue
- Ultrasonically stitched
- High-Pressure Liquid Proof
- Laboratory Tested
- High Strength
- All Sizes Available
- Welded cuffs

### DIMENSIONS IN (inch)

	S	M	L	XL	2XL
A	57,1	59,1	61,0	63,0	63,0
B	39,4	41,3	43,3	45,3	47,2
C	7,5	7,9	8,3	8,7	9,3
D	21,7	22,0	22,4	22,8	23,2
E	10,6	10,6	11,0	11,0	11,8
F	6,3	6,3	6,7	6,7	7,5

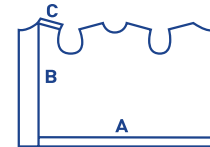

### DIMENSIONS IN (cm)

	S	M	L	XL	2XL
A	145,0	150,0	155,0	160,0	163,0
B	100,0	105,0	110,0	115,0	120,0
C	19,0	20,0	21,0	22,0	23,5
D	55,0	56,0	57,0	58,0	59,0
E	27,0	27,0	28,0	28,0	30,0
F	16,0	16,0	17,0	17,0	19,0



EN 13795-1



45001:2018



13485:2016



9001:2015



14001:2015



# gowns

## Surgical Gown Level 3

### COLORS

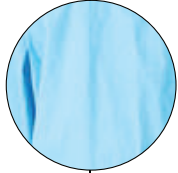

EKM-SG-L3001 (Non-sterile)  
EKM-SG-L3005 (Sterile)

A surgical gown is a personal protective garment intended to be worn by health care personnel during surgical procedures to protect both the patient and health care personnel from the transfer of microorganisms, body fluids, and particulate matter.

- 100% SS/MMS+PE/ S+SS/MMS+PE/ S+SMMS+PE/
- 50/60 GSM - 1.47/1.77 OYS
- Ultrasonically stitched
- High-Pressure Liquid Proof
- Laboratory Tested
- High Strength
- All Sizes Available

### DIMENSIONS IN (inch)

	S	M	L	XL	2XL
A	57,1	59,1	61,0	63,0	63,0
B	39,4	41,3	43,3	45,3	47,2
C	7,5	7,9	8,3	8,7	9,3
D	21,7	22,0	22,4	22,8	23,2
E	10,6	10,6	11,0	11,0	11,8
F	6,3	6,3	6,7	6,7	7,5

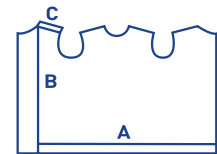

### DIMENSIONS IN (cm)

	S	M	L	XL	2XL
A	145,0	150,0	155,0	160,0	163,0
B	100,0	105,0	110,0	115,0	120,0
C	19,0	20,0	21,0	22,0	23,5
D	55,0	56,0	57,0	58,0	59,0
E	27,0	27,0	28,0	28,0	30,0
F	16,0	16,0	17,0	17,0	19,0





# gowns

## Surgical Gown Level 4

### COLORS



EKM-SG-L4001 (Non-sterile)  
EKM-SG-L4005 (Sterile)

A surgical gown is a personal protective garment intended to be worn by health care personnel during surgical procedures to protect both the patient and health care personnel from the transfer of microorganisms, body fluids, and particulate matter.

- 100% SS/MMS+PE / S+SSMMS+PE / S+SMMS+PE /
- 50/60 GSM - 1.47/1.77 OYS
- Ultrasonically stitched
- High-Pressure Liquid Proof
- Laboratory Tested
- High Strength
- All Sizes Available
- Welded cuffs

### DIMENSIONS IN (inch)

	S	M	L	XL	2XL
A	57,1	59,1	61,0	63,0	63,0
B	39,4	41,3	43,3	45,3	47,2
C	7,5	7,9	8,3	8,7	9,3
D	21,7	22,0	22,4	22,8	23,2
E	10,6	10,6	11,0	11,0	11,8
F	6,3	6,3	6,7	6,7	7,5

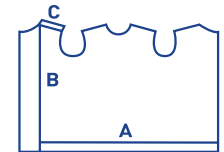

### DIMENSIONS IN (cm)

	S	M	L	XL	2XL
A	145,0	150,0	155,0	160,0	163,0
B	100,0	105,0	110,0	115,0	120,0
C	19,0	20,0	21,0	22,0	23,5
D	55,0	56,0	57,0	58,0	59,0
E	27,0	27,0	28,0	28,0	30,0
F	16,0	16,0	17,0	17,0	19,0

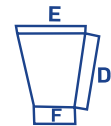

# gowns

## Surgical Isolation Gown

### COLORS

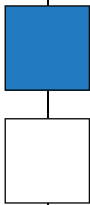

EKM-SIG-L4001 (Non-sterile)  
EKM-SIG-L4005 (Sterile)

Surgical isolation gowns are used when there is a medium to high risk of contamination and a need for larger critical zones than traditional surgical gowns. All areas of the surgical isolation gown except bindings, cuffs, and hems are considered critical zones of protection and meets the highest liquid barrier protection level for which the gown is rated.

- 100% PP+PE/SMS/SMMS/SSMMS+PE
- 40/65 GSM - 1.18/1.92 OYS
- Ultrasonically stitched
- High-Pressure Liquid Proof
- Laboratory Tested
- High Strength
- All Sizes Available

### DIMENSIONS IN (inch)

	S	M	L	XL	2XL
A	57,1	59,1	61,0	63,0	63,0
B	39,4	41,3	43,3	45,3	47,2
C	7,5	7,9	8,3	8,7	9,3
D	21,7	22,0	22,4	22,8	23,2
E	10,6	10,6	11,0	11,0	11,8
F	6,3	6,3	6,7	6,7	7,5

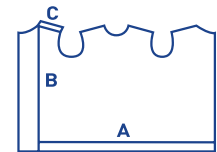

### DIMENSIONS IN (cm)

	S	M	L	XL	2XL
A	145,0	150,0	155,0	160,0	163,0
B	100,0	105,0	110,0	115,0	120,0
C	19,0	20,0	21,0	22,0	23,5
D	55,0	56,0	57,0	58,0	59,0
E	27,0	27,0	28,0	28,0	30,0
F	16,0	16,0	17,0	17,0	19,0



## Chemo Gown

### COLORS

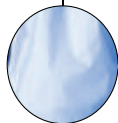

EKM-CHG-L4001 (Non-sterile)  
EKM-CHG-L4005 (Sterile)

Chemo gowns tested 480 minutes against following chemotherapy drugs and no breakouts observed as meeting standards of ASTM F739-12;

- |                                |                         |
|--------------------------------|-------------------------|
| 1. Carmustine                  | 9. Fluorouracil         |
| 2. Cisplatin                   | 10. Ifosfamid           |
| 3. Cyclophosphamide            | 11. Methotrexat         |
| 4. Cytarabine Hydrochloride    | 12. Mitomycin C         |
| 5. Dacarbazine                 | 13. Mitoxantrone        |
| 6. Daunorubicine Hydrochloride | 14. Paclitaxel          |
| 7. Doxorubicin Hydrochloride   | 15. Thiotepa            |
| 8. Etoposide                   | 16. Vincristine Sulfate |

- 100% Poly-Coated PP/ SMS+PE SSMMS/SMMS Non-Woven+PE
- 40/60 GSM - 1.18/1.77 OYS
- White or Blue
- High-Pressure Liquid Proof
- Laboratory Tested
- High Strength
- All Sizes Available

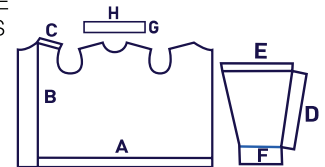

### DIMENSIONS IN (inch)

	S	M	L	XL	2XL
A	57,1	59,0	61,0	63,0	64,2
B	39,4	41,3	43,3	45,3	47,2
C	7,5	7,9	8,3	8,7	9,3
D	21,7	22,0	22,4	22,8	23,2
E	10,6	10,6	11,0	11,0	11,8
F	6,3	6,3	6,7	6,7	7,5
G	1,8	1,8	1,8	1,8	1,8
H	6,9	7,3	7,7	8,1	8,5

### DIMENSIONS IN (cm)

	S	M	L	XL	2XL
A	145,0	150,0	155,0	160,0	163,0
B	100,0	105,0	110,0	115,0	120,0
C	19,0	20,0	21,0	22,0	23,5
D	55,0	56,0	57,0	58,0	59,0
E	27,0	27,0	28,0	28,0	30,0
F	16,0	16,0	17,0	17,0	19,0
G	4,5	4,5	4,5	4,5	4,5
H	17,5	18,5	19,5	20,5	21,5

ASTM F-1670  
ASTM F-1671  
ASTM F739-12



ISO  
45001:2018

ISO  
13485:2016

ISO  
9001:2015

ISO  
14001:2015

# gowns

## Washable Gowns

### COLORS



EKM-WG-001

- Reusable gowns are manufactured with fabrics made from polyester, carbon (polycarbonate) and pre coating material.
- 180 GSM - 5.31 OYS
- Laboratory Tested
- All Sizes Available

### DIMENSIONS IN (inch)

	S	M	L	XL	2XL
A	57,1	59,1	61,0	63,0	63,0
B	39,4	41,3	43,3	45,3	47,2
C	7,5	7,9	8,3	8,7	9,3
D	21,7	22,0	22,4	22,8	23,2
E	10,6	10,6	11,0	11,0	11,8
F	6,3	6,3	6,7	6,7	7,5

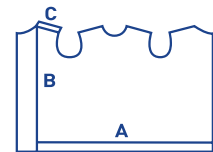

### DIMENSIONS IN (cm)

	S	M	L	XL	2XL
A	145,0	150,0	155,0	160,0	163,0
B	100,0	105,0	110,0	115,0	120,0
C	19,0	20,0	21,0	22,0	23,5
D	55,0	56,0	57,0	58,0	59,0
E	27,0	27,0	28,0	28,0	30,0
F	16,0	16,0	17,0	17,0	19,0

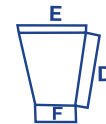

45001:2018

13485:2016

9001:2015

14001:2015



## Disposable Halter Neck (PE)

### COLORS



EKM-HN-001 (50 GSM-1.47 OYS)  
EKM-HN-008 (25 GSM-0.74 OYS)

- Polyethylene Film (PE)
- No Stitches
- 25/50 GSM - 0.74/1.47 OYS
- White or Blue
- Liquid Proof
- High Strength
- All Sizes Available

### DIMENSIONS IN (inch)

	S	M	L	XL	2XL
A	57,1	59,1	61,0	63,0	64,2
B	39,4	41,3	43,3	45,3	47,2
C	8,1	8,3	8,5	8,7	8,9

### DIMENSIONS IN (cm)

	S	M	L	XL	2XL
A	145	150	155	160	163
B	100	105	110	115	120
C	20,5	21	21,5	22	22,5

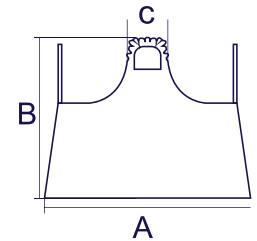



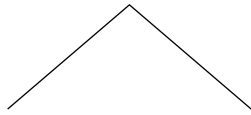
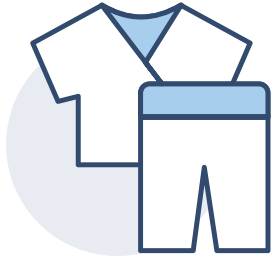

# scrub suits

- V-Neck Scrubs
- Crew Neck Scrubs
- Scrubs



# scrub suits

## Scrubs V-neck

### COLORS



- EKM-VSS-001 (Non-sterile) • EKM-VSS-005 (Sterile) • EKM-VST-001 (Non-sterile Scrubs Top Only) • EKM-VST-005 (Sterile Scrubs Top Only) • EKM-SCP-001 (Non-sterile Scrubs Pants Only) • EKM-SCP-005 (Sterile Scrubs Pants Only)

Our unisex scrub suits are made of a high-quality SS/SMS fabric that combines strength, softness and comfort. Short-sleeve tops feature an easy-to-don v-neck and two large front pockets. Pants are constructed with an elastic waist.

- 100% SMS/SS Non-Woven • Laboratory Tested
- 30/40 GSM - 0.88/1.18 OYS • All Sizes Available

DIMENSIONS IN (inch)		TOP				
	S	M	L	XL	2XL	
A	27,95	28,74	29,53	30,31	31,10	
A1	24,41	25,20	25,98	26,77	27,56	
O	20,87	21,65	22,44	23,23	24,02	
C	8,66	9,06	9,45	9,84	10,24	
D	9,65	10,04	10,43	10,83	11,22	
E	9,06	9,25	9,45	9,65	9,84	
F	8,17	8,27	8,37	8,46	8,56	

DIMENSIONS IN (cm)		GOMMAGE				
	S	M	L	XL	2XL	
A	71,0	73,0	75,0	77,0	79,0	
A1	62,0	64,0	66,0	68,0	70,0	
O	53,0	55,0	57,0	59,0	61,0	
C	22,0	23,0	24,0	25,0	26,0	
D	24,5	25,5	26,5	27,5	28,5	
E	23,0	23,5	24,0	24,5	25,0	
F	20,75	21,0	21,25	21,5	21,75	

DIMENSIONS IN (inch)		PANTS				
	S	M	L	XL	2XL	
K	13,39	14,17	14,96	15,75	16,54	
L	12,20	12,60	12,99	13,39	13,78	
M	15,75	16,14	16,54	16,93	17,32	
N	20,87	21,65	22,44	23,23	24,02	
P	12,99	13,39	13,78	14,17	14,57	
R	7,87	8,07	8,27	8,46	8,66	
S	28,74	29,13	29,53	29,92	30,31	

DIMENSIONS IN (cm)		PANTALONS				
	S	M	L	XL	2XL	
K	34,0	36,0	38,0	40,0	42,0	
L	31,0	32,0	33,0	34,0	35,0	
M	40,0	41,0	42,0	43,0	44,0	
N	53,0	55,0	57,0	59,0	61,0	
P	33,0	34,0	35,0	36,0	37,0	
R	20,0	20,5	21,0	21,5	22,0	
S	73,0	74,0	75,0	76,0	77,0	

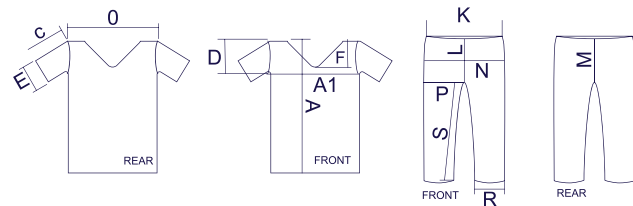

45001:2018

13485:2016

9001:2015

14001:2015



## Scrubs Crew Neck

### COLORS

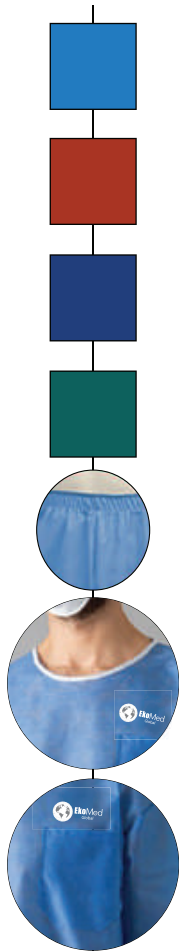

- EKM-CSS-001 (Non-sterile) • EKM-CSS-005 (Sterile)
- EKM-CST-001 (Non-sterile Scrubs Top Only)
- EKM-CST-005 (Sterile Scrubs Top Only)

Our unisex scrub suits are made of a high-quality SS/SMS fabric that combines strength, softness and comfort. Short sleeve tops feature an easy-to-don Crew-neck and two large front pockets. Pants are constructed with an elastic waist.

- 100% SMS/SS Non-Woven
- Laboratory Tested
- 30/40 GSM - 0.88/1.18 OYS
- All Sizes Available

DIMENSIONS IN (inch)						TOP	DIMENSIONS IN (cm)						GOMMAGE
	S	M	L	XL	2XL		S	M	L	XL	2XL		
A	27,95	28,74	29,53	30,31	31,10		71,0	73,0	75,0	77,0	79,0		
A1	24,41	25,20	25,98	26,77	27,56		62,0	64,0	66,0	68,0	70,0		
O	20,87	21,65	22,44	23,23	24,02		53,0	55,0	57,0	59,0	61,0		
C	8,66	9,06	9,45	9,84	10,24		22,0	23,0	24,0	25,0	26,0		
D	9,65	10,04	10,43	10,83	11,22		24,5	25,5	26,5	27,5	28,5		
E	9,06	9,25	9,45	9,65	9,84		23,0	23,5	24,0	24,5	25,0		

PANTS						PANTALONS					
	S	M	L	XL	2XL		S	M	L	XL	2XL
K	13,39	14,17	14,96	15,75	16,54	K	34,0	36,0	38,0	40,0	42,0
L	12,20	12,60	12,99	13,39	13,78	L	31,0	32,0	33,0	34,0	35,0
M	15,75	16,14	16,54	16,93	17,32	M	40,0	41,0	42,0	43,0	44,0
N	20,87	21,65	22,44	23,23	24,02	N	53,0	55,0	57,0	59,0	61,0
P	12,99	13,39	13,78	14,17	14,57	P	33,0	34,0	35,0	36,0	37,0
R	7,87	8,07	8,27	8,46	8,66	R	20,0	20,5	21,0	21,5	22,0
S	28,74	29,13	29,53	29,92	30,31	S	73,0	74,0	75,0	76,0	77,0

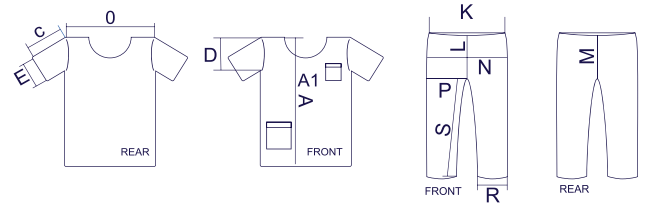



# scrub suits

## Crew-Neck Scrubs Top & Pants Pocket Trousers

### COLORS



EKM-CSS-003 (Non-sterile)  
EKM-SCP-002 (Non-sterile Scrubs Pants Only)

Our unisex scrub suits are made of a high-quality SS/SMS fabric that combines strength with softness and comfort. The short sleeve top feature an easy-to-don Crew-neck and two large front pockets. The pants are constructed with an elasticated and lace-up waist.

- 100% SMS/SS Non-Woven
- Laboratory Tested
- 30/40 GSM - 0.88/1.18 OYS
- All Sizes Available

DIMENSIONS IN (inch)						DIMENSIONS IN (cm) GOMMAGE					
TOP						PANTALONS					
	S	M	L	XL	2XL		S	M	L	XL	2XL
A	27,95	28,74	29,53	30,31	31,10	A	71,0	73,0	75,0	77,0	79,0
A1	24,41	25,20	25,98	26,77	27,56	A1	62,0	64,0	66,0	68,0	70,0
O	20,87	21,65	22,44	23,23	24,02	O	53,0	55,0	57,0	59,0	61,0
C	8,66	9,06	9,45	9,84	10,24	C	22,0	23,0	24,0	25,0	26,0
D	9,65	10,04	10,43	10,83	11,22	D	24,5	25,5	26,5	27,5	28,5
E	9,06	9,25	9,45	9,65	9,84	E	23,0	23,5	24,0	24,5	25,0
PANTS						PANTALONS					
	S	M	L	XL	2XL		S	M	L	XL	2XL
K	13,39	14,17	14,96	15,75	16,54	K	34,0	36,0	38,0	40,0	42,0
L	12,20	12,60	12,99	13,39	13,78	L	31,0	32,0	33,0	34,0	35,0
M	15,75	16,14	16,54	16,93	17,32	M	40,0	41,0	42,0	43,0	44,0
N	20,87	21,65	22,44	23,23	24,02	N	53,0	55,0	57,0	59,0	61,0
P	12,99	13,39	13,78	14,17	14,57	P	33,0	34,0	35,0	36,0	37,0
R	7,87	8,07	8,27	8,46	8,66	R	20,0	20,5	21,0	21,5	22,0
S	28,74	29,13	29,53	29,92	30,31	S	73,0	74,0	75,0	76,0	77,0

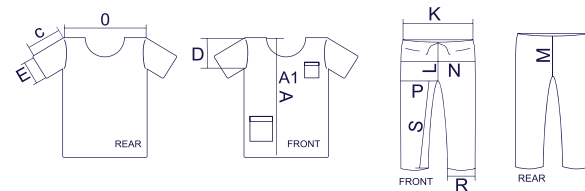

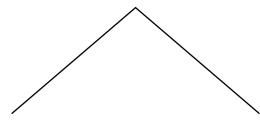
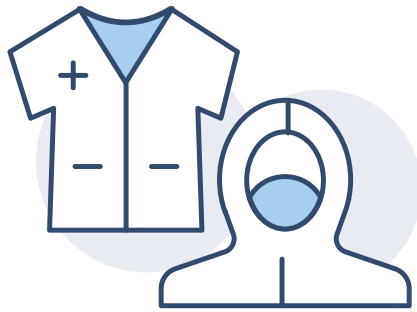

# lab coats and jackets protective coveralls

Protective Coverall Type 3-4

Protective Coverall Type 5-6

Protective Coverall Type 6



# lab coats and jackets protective coveralls

## Lab Coats

### COLORS



EKM-LBC-001 (Non-sterile)  
EKM-LBC-005 (Sterile)



Our unisex lab coat is made of a high-quality SS/SMS fabric that combines strength with softness and comfort.

- 100% SMS/SS Non-Woven
- High Strength
- 30/40 GSM - 0.88/1.18 OYS
- All Sizes Available
- Laboratory Tested

### DIMENSIONS IN (inch)

	S	M	L	XL	2XL
A	41,7	42,5	43,3	44,1	44,9
A1	24,6	25,6	26,6	27,6	28,5
O	24,6	25,6	26,6	27,6	28,5
C	10,6	10,6	11,0	11,0	11,8
D	21,7	22,0	22,4	22,8	23,6
E	6,3	6,3	6,7	6,7	7,5

### DIMENSIONS IN (cm)

	S	M	L	XL	2XL
A	106,0	108,0	110,0	112,0	114,0
A1	62,5	65,0	67,5	70,0	72,5
O	62,5	65,0	67,5	70,0	72,5
C	27,0	27,0	28,0	28,0	30,0
D	55,0	56,0	57,0	58,0	60,0
E	16,0	16,0	17,0	17,0	19,0

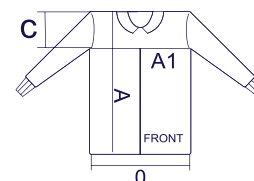

# Lab Jackets

lab coats and jackets  
protective coveralls

## COLORS



EKM-LBJ-001 (Non-sterile)  
EKM-LBJ-005 (Sterile)



Our unisex lab jacket is made of a high-quality SS/SMS fabric that combines strength with softness and comfort.

- 100% SMS/SS Non-Woven
- 30/40 GSM - 0.88/1.18 OYS
- Laboratory Tested
- High Strength
- All Sizes Available

### DIMENSIONS IN (inch)

	S	M	L	XL	2XL
A	28,0	28,7	29,5	30,3	31,1
A1	25,0	25,8	26,6	27,4	28,5
O	25,0	25,8	26,6	27,4	28,5
C	9,4	9,8	10,2	10,6	11,0
D	21,7	22,0	22,4	22,8	23,6
E	6,1	6,3	6,5	6,7	6,9

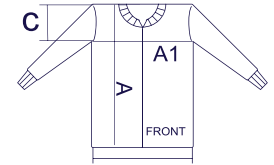

### DIMENSIONS IN (cm)

	S	M	L	XL	2XL
A	71,0	73,0	75,0	77,0	79,0
A1	63,5	65,5	67,5	69,5	72,5
O	63,5	65,5	67,5	69,5	72,5
C	24,0	25,0	26,0	27,0	28,0
D	55,0	56,0	57,0	58,0	60,0
E	15,5	16,0	16,5	17,0	17,5



lab coats and jackets  
protective coveralls

# Protective Coverall, Disposable, Type 3-4

COLORS



EKM-OVA-L4001

EkoMed's Disposable Protective Coverall has good anti-filtration performance, high filtering efficiency, surface moisture resistance, strength, and air permeability, which allows it to effectively prevent dust, water, bacteria, and viruses.

- SMS (Laminated) / PP+PE
- 50/60 GSM - 1.47/1.77 OYS
- High-Pressure Liquid Proof
- Laboratory Tested
- High Strength
- All Sizes Available

DIMENSIONS IN (inch)

(inch)	S	M	L	XL	2XL
Round	33,07-36,22	36,22-39,4	39,4-42,52	42,52-45,67	45,67-48,82
Height	63,80-66,94	66,15-69,30	68,51-71,66	70,87-74,02	73,23-76,38

DIMENSIONS IN (cm)

(cm)	S	M	L	XL	2XL
Round	84-92	92-100	100-108	108-116	116-124
Height	162-170	168-176	174-182	180-188	186-194

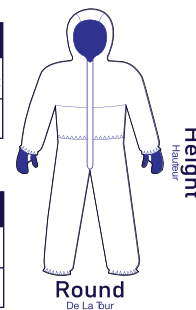

EN 13034+A1



EN 14605+A1



EN 13688



EN 1073-2



EN 14126



EN 1149-5



Type 3



Type 4

EN ISO  
13982-1



Type 5



Type 6



GMP  
Quality



45001:2018



13485:2016



9001:2015



14001:2015



lab coats and jackets  
protective coveralls

# Protective Coverall, Disposable, Type 5-6

COLORS



EKM-OVA-L5001

EkoMed's Disposable Protective Coverall has good anti-filtration performance, high filtering efficiency, surface moisture resistance, strength, and air permeability, which allows it to effectively prevent dust, water, bacteria, and viruses.

- SMS (Laminated) / PP+PE
- 50/60 GSM - 1.47/1.77 OYS
- High-Pressure Liquid Proof
- Laboratory Tested
- High Strength
- All Sizes Available

DIMENSIONS IN (inch)

(inch)	S	M	L	XL	2XL
Round	33,07-36,22	36,22-39,4	39,4-42,52	42,52-45,67	45,67-48,82
Height	63,80-66,94	66,15-69,30	68,51-71,66	70,87-74,02	73,23-76,38

DIMENSIONS IN (cm)

(cm)	S	M	L	XL	2XL
Round	84-92	92-100	100-108	108-116	116-124
Height	162-170	168-176	174-182	180-188	186-194

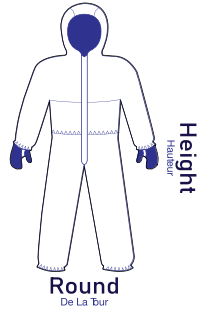



# Disposable Coverall, Type 6

## COLORS



EKM-OVA-L6001

EkoMed's Disposable Protective Coverall has good anti-filtration performance, high filtering efficiency, surface moisture resistance, strength, and air permeability.

- SMS / SS
- 40 GSM - 1.18 OYS
- Laboratory Tested
- Strength
- All Sizes Available

### DIMENSIONS IN (inch)

(inch)	S	M	L	XL	2XL
Round	33,07-36,22	36,22-39,4	39,4-42,52	42,52-45,67	45,67-48,82
Height	63,80-66,94	66,15-69,30	68,51-71,66	70,87-74,02	73,23-76,38

### DIMENSIONS IN (cm)

(cm)	S	M	L	XL	2XL
Round	84-92	92-100	100-108	108-116	116-124
Height	162-170	168-176	174-182	180-188	186-194

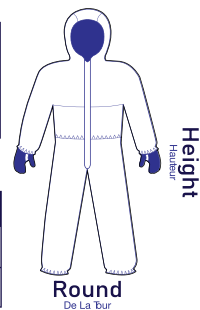

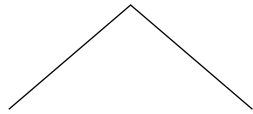
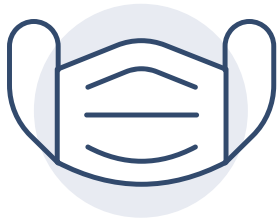

# face masks

Surgical Face Masks

3 Layer Face Masks

FFP2 & FFP3



# face mask

## Surgical Face Mask EU Type 1 - ASTM LVL 1

### COLORS

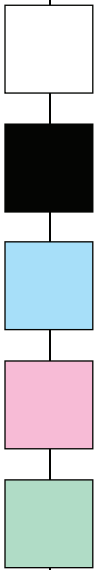

EKM-3LSM-101 (NEW GENERATION)

- 3 layer hypoallergenic non-woven material (Spunbon+Meltblown +Spunbon)
- Polypropylene (PP) covered soft & adjustable nose wire
- Ultrasonic seam
- Single-use
- High Filtration Efficiency, BFE > 95%
- Comfortable inhalation and exhalation
- 2 alternative for ear loops
  - Soft elastic ear loops
  - Ultra soft elastic ear loops (New generation)
- Light, soft and skin-friendly



EKM-3LSM-001



EN14683



Typ I

# Surgical Face Mask EU Type II - ASTM LVL 2

face mask

COLORS

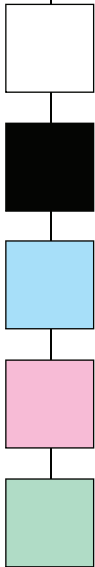

EKM-3LSM-102 (NEW GENERATION)

- 3 layer hypoallergenic non-woven material (Spunbon+Meltblown +Spunbon)
- Polypropylene (PP) covered soft & adjustable Nose wire
- Ultrasonic seam
- Single-use
- High Filtration Efficiency, BFE > 98%
- Comfortable inhalation and Exhalation
- 2 alternative for ear loops
  - Soft elastic aer loops
  - Ultra soft elastic ear loops (New generation)
- Light, soft and skin-friendly



EKM-3LSM-002



EN14683



Typ II

# face mask

## Surgical Face Mask EU Type IIR - ASTM LVL 3

### COLORS

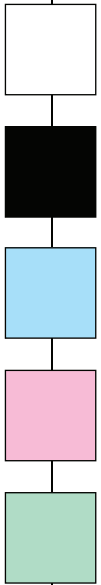

EKM-3LSM-103 (NEW GENERATION)

- 3 Layer hypoallergenic non-woven material (Spunbon +Meltblown+Spunbon)
- Polypropylene (PP) covered soft & adjustable nose wire
- Provides protection against infections, including COVID-19 viruses
- Complies with EN 14683:2019 standard
- Effective protection from an array of pathogens and airborne particles
- Biologically protective with 98% BFE (bacterial filtration efficiency)
- 2 alternative for ear loops
  - Soft elastic aer loops
  - Ultra soft elastic ear loops (New generation)
- Non-sterile face mask, secure and comfortable fit
- Light, soft, and skin-friendly single-use mask
- Does not obstruct breathing



EKM-3LSM-003



EN14683





# Face Mask with Tie-Back

# face mask

## COLORS



EKM-3LSM-004

- 3 Layer hypoallergenic non-woven material (Spunbon+Meltblown+Spunbon)
- Particle filtration efficiency of 98% (PFE 0.1 micron)
- High bacterial filter performance (BFE)
- Secure and comfortable fit
- No skin irritation
- Comfortable inhalation and exhalation
- Integrated adjustable nose bridge strip clip for the best fit
- Elasticated soft ear loops, splash resistant
- Non-sterile face mask, secure and comfortable fit
- Light, soft and skin-friendly single-use mask
- Does not obstruct breathing



45001:2018



13485:2016



9001:2015



14001:2015



EN14683



**EkoMed**  
Global Asia  
意可曼医疗用品有限公司

# face mask

## Face Masks for Child

### COLORS



EKM-3LFM-004

- 3 Layer hypoallergenic non-woven material (Spunbon+Meltblown +Spunbon)
- Particle filtration efficiency of 98% (PFE 0.1 micron)
- High bacterial filter performance (BFE)
- Secure and comfortable fit
- No skin irritation
- Comfortable inhalation and exhalation
- Produced in various colors and patterns
- Integrated adjustable nose bridge strip clip for the best fit
- Elasticated soft ear loops, splash resistant
- Non-sterile face mask, secure and comfortable fit
- Light, soft, and skin-friendly single-use mask
- Does not obstruct breathing



## Foldable Protective Face Mask - FFP2

### COLORS



FFP2 protects against solid and liquid particles, excluding carcinogenic and radioactive substances, airborne biological substances from risk groups 2 and 3 and enzymes.

- Product Type: Foldable Protective Mask
- Hazard Type: General respiratory protective equipment
- Closure Type: Flexible holder
- Material: 5 layers of fabric (3 Layer spunbond and 2 Layer meltblown)
- Filtration Efficiency: 95% $\geq$
- Masks are designed to protect against harmful substances, contamination, bacteria and viruses. It is the user's responsibility to determine the suitability of the masks and use them in accordance with the instructions.
- Comfort Features: Friendly material, elastic holders for a perfect fit, it easily covers the mouth and nose area.



EKM-FFP2-004



45001:2018



13485:2016



9001:2015



14001:2015

CE

# face mask

## FFP2 Face Mask

### COLORS



- A face mask with code FFP2 protects against very fine particles such as asbestos and ceramic
- Offers the highest protection from hazardous substances.
- Ultrasonic welding
- Use in a dusty environment
- Prevent risky infectious diseases. (According to national recommendations in force)
- Non-woven, and elastic ear loops
- Cup-shaped, Micro Filter Layer and Non-Allergic
- Activated Carbon Filter
- Provide good two-way protection, by filtering both inflow and outflow of air
- Aerosol Filtration percentage: 95% minimum
- With metal or plastic wire option



EKM-FFP2-006 (Without Vent)



CE

## FFP2 Face Mask (with vent)

### COLORS

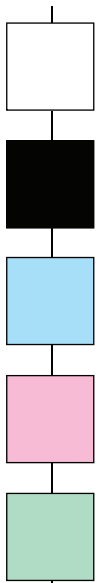

- A face mask with code FFP2 protects against very fine particles such as asbestos and ceramic
- Offers the highest protection from hazardous substances.
- Ultrasonic welding
- Use in a dusty environment
- Prevent risky infectious diseases. (According to national recommendations in force)
- Non-woven, and elastic ear loops
- Cup-shaped, Micro Filter Layer and Non-Allergic Activated Carbon Filter
- Provides good two-way protection, by filtering both inflow and outflow of air
- Aerosol Filtration percentage: 95% minimum
- It protects against very fine particles such as asbestos and ceramic
- With metal or plastic wire loops



EKM-FFP2-001 (With Antifogging Vent)



CE



# face mask

## Foldable Protective Face Mask - FFP3

### COLORS

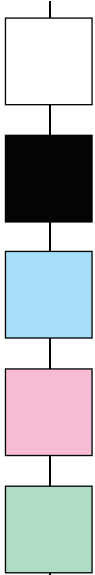

FFP3 protects against solid and liquid particles, excluding carcinogenic and radioactive substances, airborne biological substances from risk groups 2 and 3 and enzymes.

- Product Type: Foldable Protective Mask
- Hazard Type: General respiratory protective equipment
- Closure Type: Flexible holder
- Material: 5 layers of fabric (3 Layer Spunbond and 2 Layer meltblown)
- Filtration Efficiency:  $\geq 99\%$
- Masks are designed to protect against harmful substances, contamination, bacteria and viruses. It is the user's responsibility to determine the suitability of the masks and use them in accordance with the instructions.
- Comfort Features: Friendly material, elastic holders for a perfect fit, it easily covers the mouth and nose area.



EKM-FFP3-004



## FFP3 Face Mask (with vent)

### COLORS



- A face mask with code FFP3 protects against very fine particles such as asbestos and ceramic
- Offers the highest protection from hazardous substances.
- Ultrasonic welding
- Use in a dusty environment
- Prevent risky infectious diseases. (According to national recommendations in force)
- Non-woven, and Elastic ear loops
- Cup-shaped, Micro Filter Layer and Non-Allergic
- Activated Carbon Filter
- Provides two-way protection, by filtering both inflow and outflow of air
- Aerosol Filtration percentage: 99% minimum
- With metal or plastic wire option



EKM-FFP3-001 (With Antifogging Vent)



45001:2018



13485:2016



9001:2015



14001:2015

# face mask

## FFP3 Face Mask

### COLORS

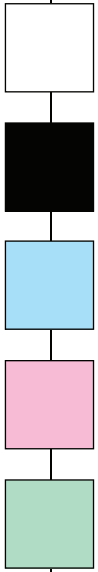

EKM-FFP3-006 (Without Vent)

- A face mask with code FFP3 protects against very fine particles such as asbestos and ceramic
- Offers the highest protection from hazardous substances.
- Ultrasonic welding
- Use in a dusty environment
- Prevent risky infectious diseases. (According to national recommendations in force)
- Non-woven, and elastic ear loops
- Cup-shaped, Micro Filter Layer and Non-Allergic
- Activated Carbon Filter
- Provides two-way protection, by filtering both inflow and outflow of air
- Aerosol Filtration percentage: 99% minimum
- With metal or plastic wire



# Respirator Comparison

# face mask

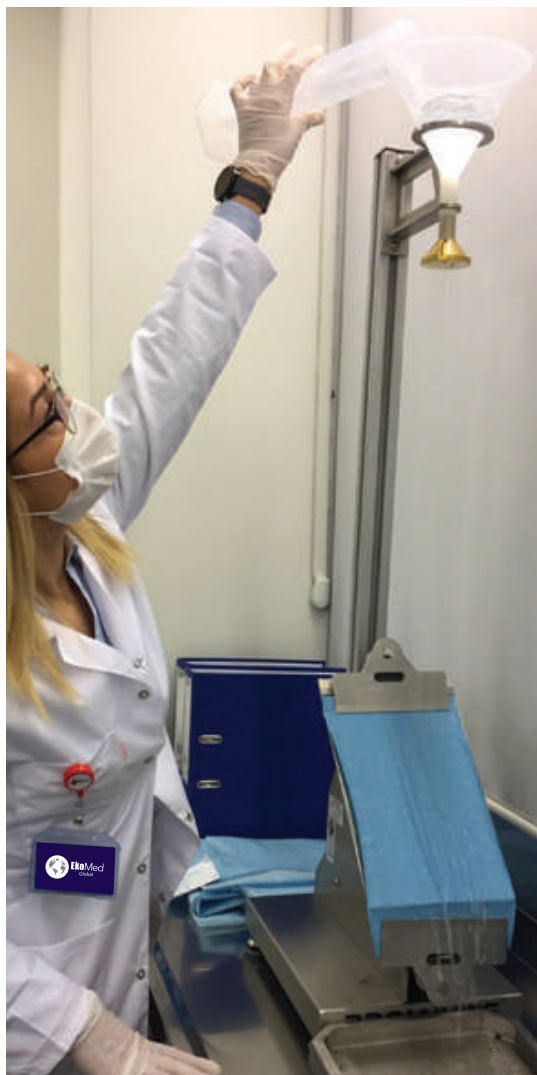

Reference standard: EN 149:2001+A1:2009 Regulation (EU) 2016/425 of the European Parliament and of the Council (09/03/2016)

The notified body involved in the conformity assessment: MNA LABORATORIES SAN ve TIC LTD STI - Küçükbakkalköy Mahallesi Yenidoğan Cad. No:21 Ataşehir / İstanbul (NB 2841)

Class	Filter penetration limit (at 95 L/min air flow)	Inward leakage	Typical Elastic Band	Vent
FFP1	Filters at least 80% of airborne particles	> 22%	Green, blue, red, orange, white	Custom color option
FFP2	Filters at least 94% of airborne particles	> 8%	Green, blue, red, orange, white	Custom color option
FFP3	Filters at least 99% of airborne particles	> 2%	Green, blue, red, orange, white	Custom color option

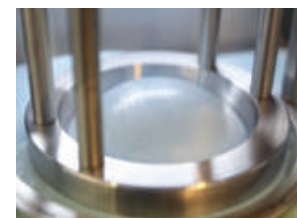
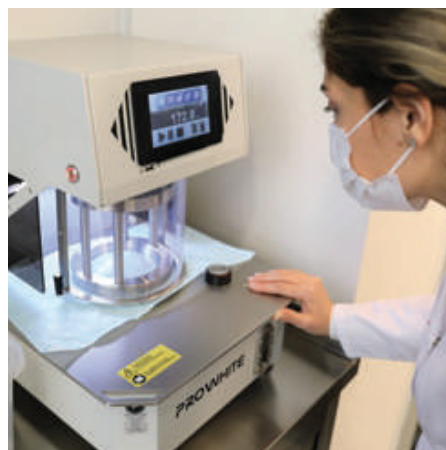







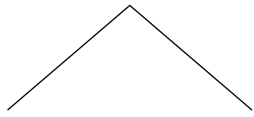
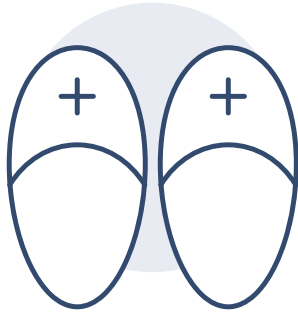

others

---

Body Bags

---

Shoe Covers

---

Bouffant and Surgical Caps

---

Hoods



other

# Body bag with Straight Zipper

COLORS

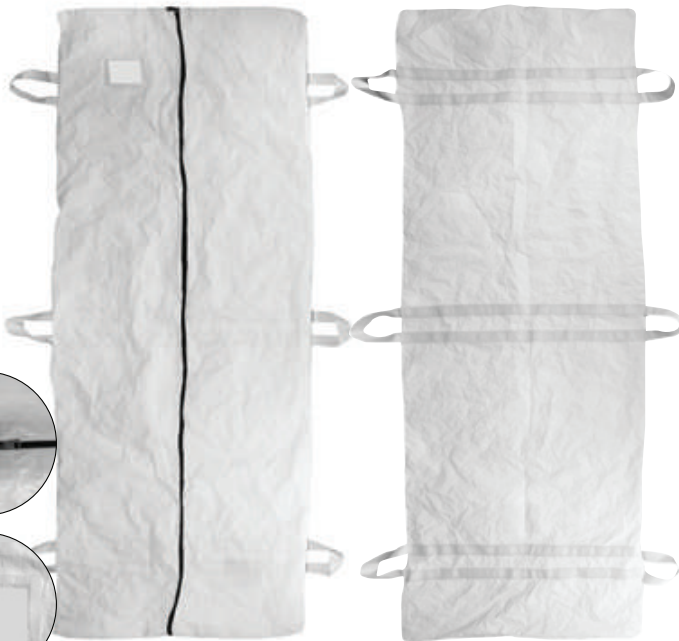

Straight zipper with 2 runners with large metal loops on each runner. Straight polyester zip closure to facilitate placing the body in the bag. Laminated, waterproof and extremely resistant. Non-PVC and Non-degradable.

- Material: High strength polyethylene (PE)
- Weight: 180 GSM - 5.31 OYS
- Size: Adult
- Handles: 6 nonsplintering handles
- Biodegradable: No
- ID/Card Holder: Yes (3 pieces)
- Rust-resistant zipper, two pulls

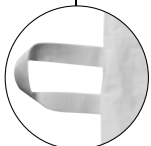
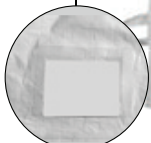
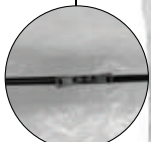
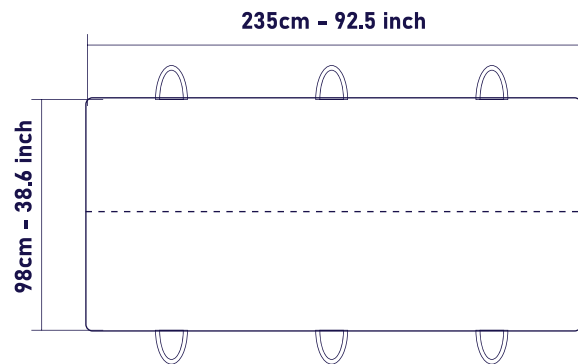

EKM-BB-001



45001:2018



13485:2016



9001:2015



14001:2015

other

# Body Bag U-Shaped Zipper

COLORS

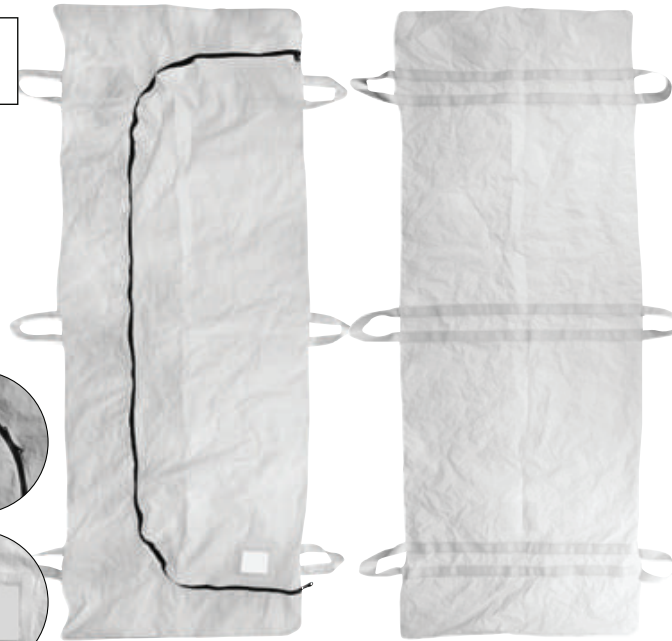

U shape zipper with 2 runners with large metal loops on each runner. U-shaped polyester zip closure to facilitate placing the body in the bag. Laminated waterproof and extremely resistant. Non-PVC and Non-degradable.

- Material: High strength polyethylene (PE)
- Weight: 180 GSM - 5.31 OYS
- Size: Adult
- Handles: 6 nonsplintering handles
- Biodegradable: No
- ID/Card Holder: Yes (3 pieces)
- Rust-resistant zipper, two pulls

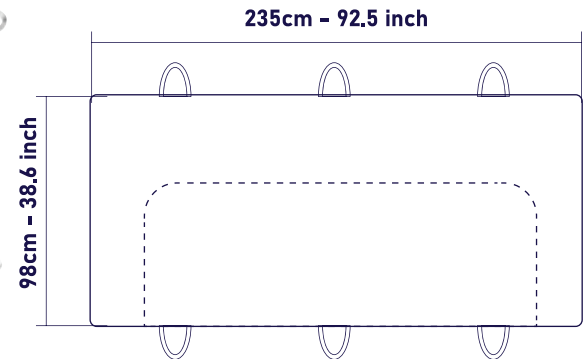

EKM-BB-002



other

# Anti-Skid Shoe Cover

COLORS



EkoMed's shoe covers are constructed from high-quality, 3 layer SMS fabric to provide complete coverage of the shoe and lower leg. The top of the shoe covers are elasticated, which helps to keep the shoe cover in place. EkoMed's shoe covers feature adhesive strips on the bottom to minimize the risk of slips and falls. A fluid-resistant coating on the shoe area provides moderate protection from fluid contact.

- 3 Layer SMS Fabric
- 40 GSM - 1.18 OYS
- Laboratory Tested
- Non-Slip Sole
- Fluid Resistant
- High Strength

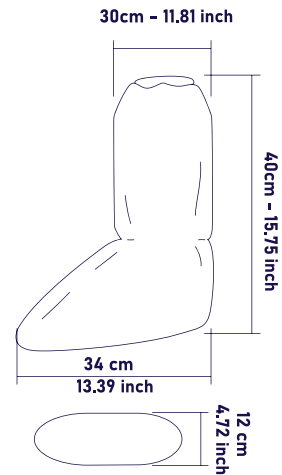

EKM-ASSC-001



# Anti-Skid Shoe Cover with Stripe

COLORS

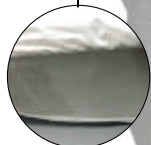

EkoMed's shoe covers are constructed from high-quality, SMS and PP+PE fabric to provide complete coverage of the shoe and lower leg. The top of the shoe covers are elasticated, which helps to keep the shoe cover in place. EkoMed's shoe covers feature adhesive strips on the bottom to minimize the risk of slips and falls. A fluid-resistant coating on the shoe area provides moderate protection from fluid contact.

- SMS+PE / PP+PE
- 50/60 GSM - 1.47/1.77 OYS
- Laboratory Tested
- Non-Slip Sole
- Fluid Resistant
- High Strength

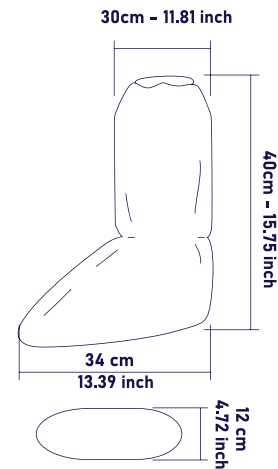

EKM-ASSC-002





other

## Anti-Skid Shoe Cover (50 GSM)

COLORS

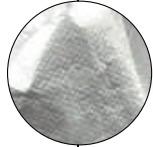
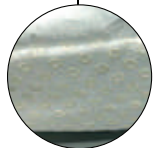

EkoMed's shoe covers are constructed from a high-quality, 3 layer SMS fabric and provides complete coverage of the shoe and lower leg. The top of the shoe covers are elasticated, which helps to keep the shoe cover in place. EkoMed's shoe covers feature adhesive strips on the bottom to minimize the risk of slips and falls. A fluid-resistant coating on the shoe area provides moderate protection from fluid contact.

- 3 Layer SMS Fabric (Laminated)
- Fluid Resistant
- 50/60 GSM - 1.47/1.77 OYS
- High Strength
- Laboratory Tested
- Non-Slip Sole

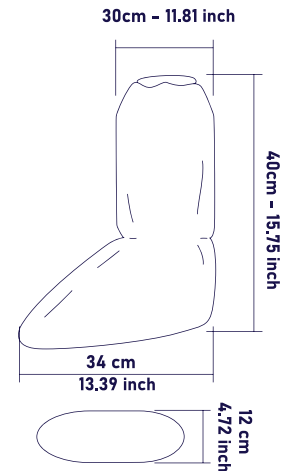

EKM-ASSC-003



other

# Anti-Skid Shoe Cover

## COLORS

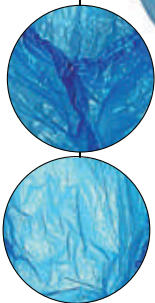

This cover is comfortable when worn over the shoes. Operation, theater, research centers, server rooms are places where this cover is worn over the shoe to stop dust and unhygienic particles from entering the room. The quality monofilament and the strong stitching make this cover highly durable and attractive.

- Polyethylene (PE)
- 20/50 GSM - 0.59/1.47 OYS
- Laboratory Tested
- Water-Resistant
- High resilience

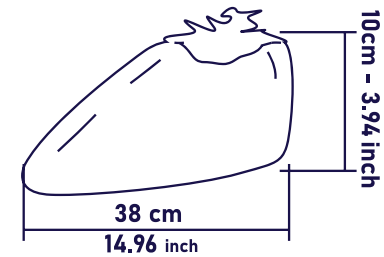

EKM-ASSC-008



other

# Bouffant Caps

COLORS

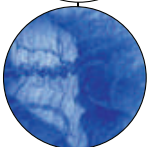

EKM-BCAPS-001

- Spunbond Non-Woven
- 30 GSM - 0.88 OYS
- Sewn-in Elastic Band
- Comfortable and Breathable
- High quality
- Various colors available

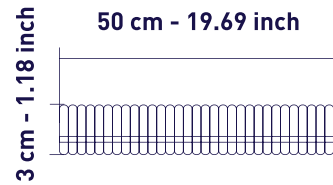

other

# Washable Surgical Cap Elastic

COLORS



EKM-SC-001

- 100% Cotton
- 100/200 GSM - 2.95/5.90 OYS
- Reusable
- Comfortable
- Washable

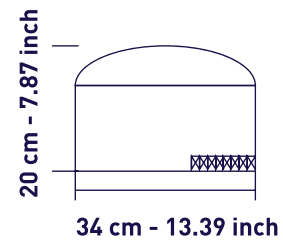

45001:2018

13485:2016

9001:2015

14001:2015

other

# Washable Surgical Cap with Tie

COLORS



- 100% Cotton
- 100/200 GSM - 2.95/5.90 OYS
- Reusable
- Comfortable
- Washable

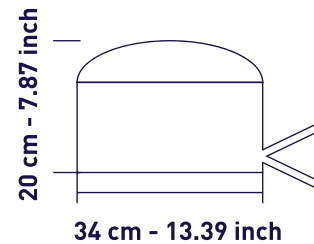

EKM-SC-003



45001:2018

13485:2016

9001:2015

14001:2015



other

# Surgical Cap Disposable

COLORS



- 100% SS/SMS
- 30/40 GSM - 0.88/1.18 OYS
- Disposable
- Comfortable

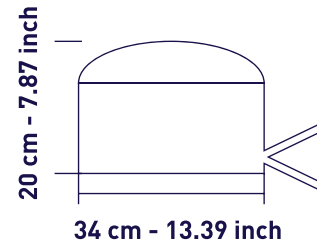

EKM-SC-004



45001:2018



13485:2016



9001:2015



14001:2015

other

# Surgical Pullover Hood

## COLORS



This surgical hood provides complete head coverage. The blue hood has a gentle elastic at the neck for a comfortable fit.

- 100% SS/SMS Non-Woven
- Disposable
- 40 GSM - 1.18 OYS
- Comfortable

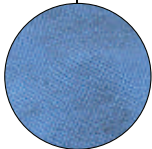
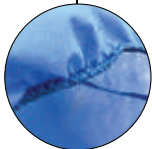
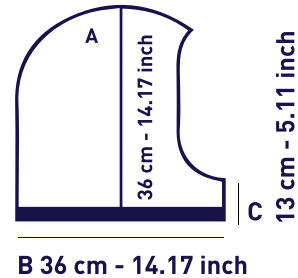

EKM-PH-001



45001:2018

13485:2016

9001:2015

14001:2015

other

# Comfort Hood

## COLORS

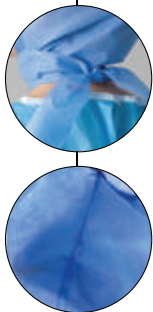

EKM-CH-001

Our cool and comfortable hood conforms to the head and neck, providing maximum coverage. Adjustable ties at the neck offer a secure and a comfortable fit.

- 100% SS/SMS Non-Woven
- 40 GSM - 1.18 OYS
- Disposable
- Comfortable

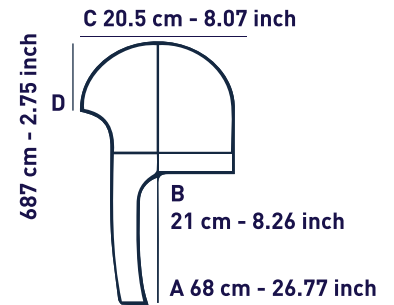

45001:2018



13485:2016



9001:2015



14001:2015

other

# Surgical Hood with Ties

COLORS



EKM-SH-001

Lightweight and comfortable, our hood provides complete head, neck and shoulder coverage. Adjustable back ties allow for a personalized fit.

- 100% SS/SMS Non-Woven
- 40 GSM - 1.18 OYS
- Disposable
- Comfortable

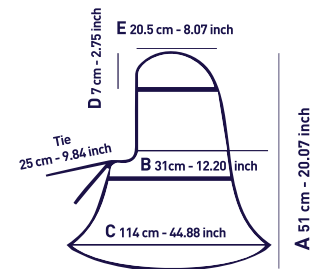

# certificates







EkoMed Global, Canada offers its customers many conveniences from storage, sales, finance to door-to-door shipping. EkoMed Canada Team has more than 20 years of industry experience.

EkoMed Global holds Health Canada medical device establishment license MDL #11585.



### Canada Headquarters

3-5510 Mainway Burlington, ON L7L6C4  
+16473306496  
sales@ekomedglobal.com





# Our Sterilization Facility



In a sterilization facility established on a total area of 2000 square meters in Hangzhou, China, in compliance with advanced technology standards, European Medical Device Directive (MDD) 93/42/ECC certified, in accordance with EO sterilization and ISO Class 7-8 clean room standards, sterilization and production of all kinds of medical equipment and medical textile products are carried out at high capacity and speed.



Sterilization comes from the word sterile which is a situation where the biological being loses the capacity to breed or reproduce. Sterilization in its origin is not only limiting the microorganisms but it is also limiting the reproductive capacity of the pathogenic agents which cause infections in the human body.

Any kind of sterilization is in essence realized for not only a point in time but a period of time in our case until the sterilization pouch made up of polyolefin in some form is a material registered under the trademark of Dupont® as Tyvek™ which has become a generic brand for those medical devices.

The content as a medical device is packaged in the sterilization pouches in controlled clean room environments and they are presented for sterilization in various sterilization devices.

There are various types of sterilization listed are below:

A. Steam Sterilization ( $H_2O_2$  / steam sterilization)

- Saturated Pure Steam (autoclave)
- Vapor-Phase Hydrogen Peroxide (isolator, clean room)

B. Dry-Heat Sterilization

- Sterilization / Depyrogenization Tunnel
- Sterilization / Depyrogenization Oven

E. Filtration

- Sterilization Grade Filter (0.2 um filter- liquid, gas / air)

C. Gas Sterilization

- Ethylene Oxide (autoclave) (flexible chamber gas diffusion ethylene oxide sterilization)
- Formaldehyde (autoclave)
- Gas-Phase Hydrogen Peroxide (isolator)

D. Ionizing Radiation

- GAMA (Cobalt 60, radio isotope decay)
- X-ray Radiation
- Electron beam radiation

Our type of ethylene oxide sterilization has been evaluated as a new generation of sterilizers known as Flexible Chamber Ethylene Oxide Gas Diffusion System Sterilizers and is a high-tech sterilizer that completes the sterilization process by using low temperature and low dose of Ethylene Oxide gas. The technology has eliminated the infrastructure requirements such as compressed air, water, vacuum lines and drainage channels required by conventional gas sterilizers. Cartridges/ampoules containing Ethylene Oxide gas are used for sterilization.



Our type of ethylene oxide sterilization has been evaluated as a new generation of sterilizers known as Flexible Chamber Ethylene Oxide Gas Diffusion System Sterilizers and is a high-tech sterilizer that completes the sterilization process by using low temperature and low dose of Ethylene Oxide gas. The technology has eliminated the infrastructure requirements such as compressed air, water, vacuum lines and drainage channels required by conventional gas sterilizers. Cartridges/ampoules containing Ethylene Oxide gas are used for sterilization.

The sterilizers we use consume one tenth of Ethylene oxide gas compared to equivalent systems. Environmental impact and pollution are minimized with low gas consumption. Ventilation after sterilization is done in the same cabin. The removal of ethylene oxide residues is made to be 100% safe with the vacuum pump system.

Within the vacuum processes used for ethylene oxide, the vacuum and the fan motor are designed to reduce the pressure in question to half an atmospheric pressure in the inner chamber used for sterilization.

In order for sterilization to be successful it is recommended to use three indicator types to monitor the process:

- Biological indicator
- Dosimeter
- Temperature sensitive chemical strip indicator

Within this process the use of biological indicators is a realistic indicator for products that are sterilized in bags, which are flexible cells.

Dosimeters only provide information about exposure to Ethylene oxide gas at sufficient concentration. They are not an indication that products are sterilized during the process.

Temperature-sensitive chemical strip indicators are indicators that the temperature has reached a level that allows Ethylene oxide sterilization within the liner bags, which are flexible cells.

For this reason, all three indicator types are advised to be used.

With the use of these indicators, you can detect if sterilization has failed.

If one of the indicators fails, sterilization has failed. A doubt means failure when using medical devices under proper conditions.

Failed Ethylene oxide sterilization should not be repeated. There could be a small amount of Ethylene oxide residue left on the products when Ethylene oxide sterilization fails. This is not a risk that should be ignored.

It is recommended that the products that have failed be destroyed to avoid being used in the future.





## China Sterilisation & Factory

No.71 Tuowu Road. Fenshui Town .tonglu, Hangzhou  
No:zhejiang province .China



# Logistic and Transportation Facilities



Quality control and loading details of all products are inspected by artificial intelligence in the storage and management facility of EkoMed Global, located on a total area of 5,000 square meters, with the RFID coding system, all processes from production to shipment are made ready for shipment at the end-to-end control point, they deliver customers and EkoMed's distribution or storage points all over the world. The facility is located in a central area with easy access and close to sea and air cargo ports.

Within the facility, 3 separate inspection rooms have been specially designed for independent inspection companies and their employees.



# EkoMed Global Inc.

## contact Information

### Canada Headquarter

3-5510 mainway  
Burlington, ON. L7L 6C4  
Canada  
(Tel) +647 330 6496  
sales@ekomedglobal.com

### Europe

(Tel) +45 426 40 799  
zayana@ekomedglobal.com

### Middle East & Africa

(Tel) +90 534 4598 27  
nasser@ekomedglobal.com

### China Manufacturing & Sterilization

NO.71 Zhe Wu Road, Fenshui Town  
Tonglu, Hangzhou, Zhejiang Province,  
China  
(Tel) +86 1506748 3435  
cooper@ekomedglobal.com

### Canada

(Tel) +647 330 6496  
sales@ekomedglobal.com

### Turkey Manufacturing

Istanbul, Turkey

### USA

(Tel) +1 917 553 3114  
wendy@ekomedglobal.com



[www.ekomedglobal.com](http://www.ekomedglobal.com)



**EkoMed**

Global Asia

意可曼医疗用品有限公司



[www.ekomedglobal.com](http://www.ekomedglobal.com)